

 SUPAIR

English



User's manual
DELIGHT 4 SPORT

SUPAIR s.a.s
PARC ALTAÏS
34 RUE ADRASTÉE
74650 CHAVANOD
FRANCE
RCS ANNECY 387956790

Revision index : V1 25/08/2022



Thank you for choosing the DELIGHT 4 SPORT. We are glad to be able to share our common paragliding passion with you.

SUPAIR has been designing, producing and selling free flying equipment since 1984. By choosing a SUPAIR product you benefit from almost forty years of expertise, innovation and listening. This is also our philosophy : working endlessly to develop better products and to maintain a high quality production.

We hope you will find this user's manual comprehensive, explicit and hopefully enjoyable as well. We advise you to read it carefully.

You will find the last-up to-date information about this product on our website www.supair.com.

If you have any further questions, feel free to ask one of our retailers for answers. And naturally, the entire SUP'AIR team is at your disposal on info@supair.com

We wish you many safe enjoyable flying hours, and happy landings.

Team SUP'AIR

LIST OF CONTENT

Introduction	4	In flight behaviour	44
Technical data	5	Flight phasis	45
Size choice	6	Take off	45
Components list	7	In-flight	46
Equipment overview	8	Speedbar use	46
Accessory assembly	9	Landing	46
Carabiners	9	Using reserve parachute	47
Back protection plate	10	Throwing	47
Seatplate	12	Towing	47
Footplate	14	Mandatory control	48
Bumpair	15	Mandatory biannual inspection	48
Speedbar	18	Care	49
Installing the reserve parachute	20	Harness cleaning maintenance	49
Main container specification	20	Storage & transport	49
Folding the reserve parachute in the pod	20	Life span	49
Reserve parachute/risers connection	23	Repair	50
Installing reserve parachute in the container	26	Hardware & parts	50
Mandatory extraction procedure	31	Recycling	50
Storage & tips	32	Warranty	51
Harness folding tips	33	Disclaimer	51
Harness adjustment	35	Pilot's gear	51
Various adjustment	35	BUMPAIR DELIGHT 4 SPORT shock absorber	52
Speedbag adjustment	36	In case of accident	54
Harness/risers connexion	38	Maintenance booklet	55
Speedbag connexion	38	Annex	56
Getting into the harness	40		
Spare parts	41		

Welcome to the paragliding world according to SUPAIR, a world of shared passion for flying.

The DELIGHT 4 SPORT is a semi-light cross country harness. Its comfortable, precise and compact features are in line with the success of the first three DELIGHT generations. Modern and ambitious, it is suitable as a first pod harness.

The DELIGHT 4 SPORT harness is perfect for traveling and compatible with occasional hike & fly. It is addressed to cross country pilots who fly an average of 4 to 5 hours.

The DELIGHT 4 SPORT harness was certified EN 1651+A1 and LTF 91/09 at 130 daN (approximately 130kg). It is also CE certified in accordance with the 89/686/CEE directive. This product meets the requirements of the EN 1651+A1 antichoc protection european norm.

After reading this manual, we suggest you to check your harness in static hang-posts to adjust it before your first flight.

The DELIGHT 4 SPORT is a “semi light” harness (made of light materials). Do not fly with shoes equipped with lacing hooks. It can tear your coverleg.

N.B : Three important icons will help you when reading this manual



Advice.



Warning !



Danger !!

TECHNICAL DATA

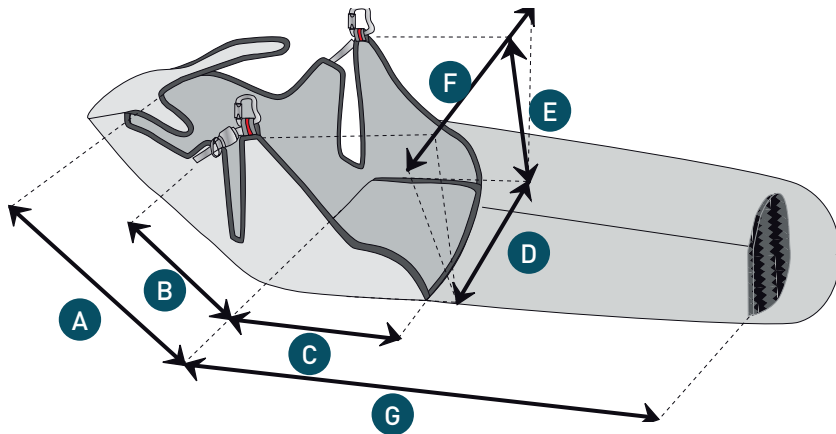

- A** Back lenght
- B** Back inclination adjustment
- C** Seat length
- D** Seat width
- E** Carabiners height
- F** Carabiners distance
- G** Speedbag length

Model	S	M	L	XL
Pilot size (cm)	155-170	165 -180	180-190	> 190
Pilot wieght (mini - maxi) (kg)	50- 75 kg	70 - 85 kg	80 - 100 kg	95 - 120 kg
Certification in load	130 dNa (approx. 130 Kg)	130 dNa (approx. 130 Kg)	130 dNa (approx. 130 Kg)	130 dNa (approx. 130 Kg)
Harness wieght (kg)	3.62	3.77	4.09	4.17
Designed for	Paragliding only			
A Back length (cm)	58	65	72	76
B Back inclination adjustment (cm)	35	36,5	41	43
C Seat length (cm)	45	45	45	49
D Seat width (cm)	33	33	35	37
E Carabiners height (cm)	45	45	46	47
F Carabiners distance (cm)	38-46	38-46	40-48	42-48
G Speedbag length (cm)	77	81	86	98
Back pocket volume (L)	21 L	22 L	27 L	29 L
Ballast pocket volume	5 L	5 L	5.5L	5.5 L
Impact dumping system	BUMPAIR FOAM			
Certification	Yes : EN 1651+A1, LTF and CE PPE			
Tandem (Pilot or Passenger)	No			
Towing	Yes			
Releasable carabiners compatibility	No			
Reserve parachute pocket volume (L)	2.9 to 5.5 Litres			

SIZE CHOICE

Choosing your harness size is important. You will find here below a height/weight table that will help you in your size choice. With its hammock architecture and its “lying flat” flying position, we advise you to try out the harness under a hanging device at one of our retailers in order to choose the correct size.

For a complete list of our retailers, please check our website : www.supair.com

Size Weight	1m50	1m55	1m60	1m65	1m70	1m75	1m80	1m85	1m90	1m95	2m00	2m05
50	S	S	S									
55	S	S	S	S	S							
60	S	S	S	S	S							
65	S	S	S	S	S	M	M					
70	S	S	S	S or M	S or M	M	M					
75			S	S or M	S or M	M	M	M or L				
80				M	M	M	M or L	M or L	L	L or XL		
85				M	M	M	M or L	M or L	L	L or XL		
90						M or L	L	L	L	L or XL	XL	XL
95							L	L	L or XL	L or XL	XL	XL
100							L	L	L or XL	XL	XL	XL
105								L or XL	XL	XL	XL	XL
110									XL	XL	XL	XL
115										XL	XL	XL
120											XL	XL

COMPONENTS LIST



- 1 Naked harness
- 2 DYNEEMA solo risers
- 3 Reserve parachute handle/pod
- 4 EDELRID FORAS automatic carabiners
- 5 Repair kit
- 6 Security leash with GRIVEL carabiner
- 7 Footplate
- 8 3B Standard speedbar
- 9 Carbon seat-plate
- 10 DELIGHT 4 BUMPAIR
- 11 Scoop mylar
- 12 Back protection plate

EQUIPMENT OVERVIEW



- 1 Cockpit
- 2 Reserve parachute pocket and handle
- 3 Main attachment points
- 4 Small storage pocket
- 5 Back storage pocket
- 6 Belly strap
- 7 Belly strap adjustment
- 8 Back inclination adjustment
- 9 Shoulder straps adjustment
- 10 Reserve parachute attachment points
- 11 Speedbar pulleys
- 12 BUMPAIR



Carabiners

Compatible carabiners :

FORAS carabiners

Ref. : MAILMOUSFORAS



Back protection plate

1. Open the back pocket zipper and spot the pocket for back protection.
2. Open the back protection pocket zipper.
3. Install the back protection with curved corners to the bottom.



ACCESSORIES ASSEMBLY

4. Make sure to push the back protection plate into the bottom of the pocket
5. Stuck the corners in the pocket to correctly install the back protection in its place.
6. Close the back protection pocket



Seatplate

The DELIGHT 4 SPORT harness can be used with and without seatplate

Flying with a seatplate provides a more rigid base and more efficient weight shifts. The harness gives more information and is more precise. The harness will also be easier to manage in case of flight envelope exit. The seatplate also contributes to a more comfortable seat without side compression.

Flying without the seatplate makes the seat soft and slightly raises the attachment points. The harness is therefore more neutral in feel and more stable. Without the seatplate, the pelvis is more stable.

Note that if the glider is out of its flight envelope, the precision of the control system must compensate for the lack of support and precision provided by the seatplate.

Compatible seatplates : S / M : Ref MPPL021 or L / XL : Ref : MPPL025

Installing the seatplate :

1. Spot the BUMPAIR, the seatplate access is under protection foams.
2. Open the BUMPAIR zipper.
3. Split the BUMPAIR in two to access the second zipper.



ACCESSORIES ASSEMBLY

4. Open the lower foam zipper
5. You will find the seatplate pocket that is closed thanks to a velcro. Open the velcro.
6. Insert the seatplate in the place with the curved side to the back.



7. Insert the seatplate all the way down.
8. Close the velcro.



Footplate

Compatible footplates : S / M : Ref MPPL010 or L / XL : Ref : MPPL024

Installing the footplate :

1. Turn the coverleg tip over.
2. Open the velcro of the pocket.
3. Insert the foot plate with the larger part upwards.
4. Fold down the top of the pocket over the plate to keep it in its place.
5. Close the velcro and put it back correctly.



Top widest side



Bottom narrowest side



The DELIGHT 4 SPORT is also compatible with the carbon footplate as an option.

Ref. :
S/M : MPPL010
L/XL : MPPL024



BUMPAIR

The DELIGHT 4 SPORT harness must be used with its BUMPAIR .

The DELIGHT 4 SPORT BUMPAIR is made of two parts. The “Upper” and the “Lower” part.



Both parts must be installed for proper operation.

Compatible BUMPAIRS :BUMPAIR DELIGHT 4

Ref. : PROBUMPD4S

Installing the BUMPAIR :

1. Fold down the harness to acces the BUMPAIR.
2. Open the first compartment (the farthest from the seat).
3. Insert the lower foam (marked “LOWER”) in its compartment (straight side toward the ballast pocket).



ACCESSORIES ASSEMBLY

4. Close the compartment thanks to the zipper.
5. Spot the second compartment.
6. Insert the upper foam (marked UPPER) in its compartment.



7. Close the compartment thanks to the zipper.
8. Fold the BUMPAIR in two.
9. Close the main zipper.



Pay attention not to stick the speedbar between the two parts of the BUMPAIR when folding and closing the protection. It would make the speedbar unusable during the flight.



BUMPAIR final position:



The zip slider of the compartments has to be correctly stored in its place in order to avoid any tangle with a strap or during the BUMPAIR manipulation.



Speedbar

Compatible speedbar :

3B STANDARDS : ACCEL3BSTD



Pay attention not to stick the speedbar between the two parts of the BUMPAIR when folding and closing the protection. It would make the speedbar unusable during the flight.

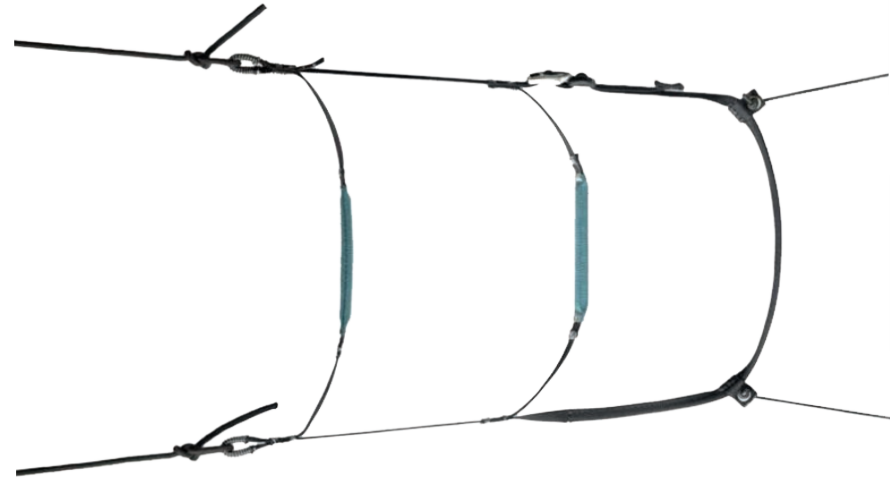

Installing speedbar :

For each side of the harness:

- 1 Fold the tip of the speedbag to access the footplate.
- 2 Pass the string through the footplate passers-by.
- 3 Attach each string with a knot .
- 4 Pass the strings in the guide rings at each side of the seat.

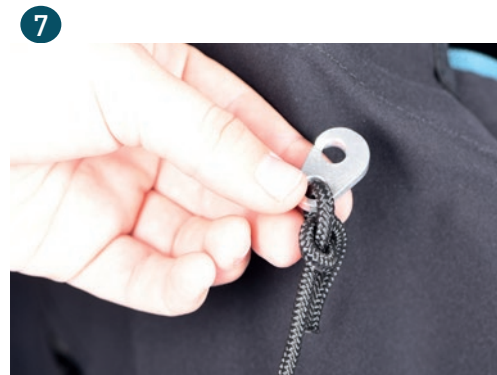
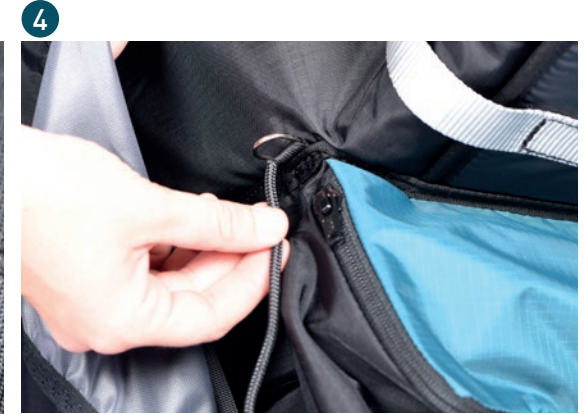
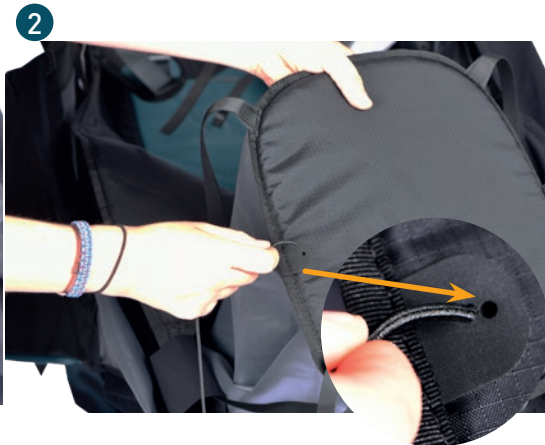
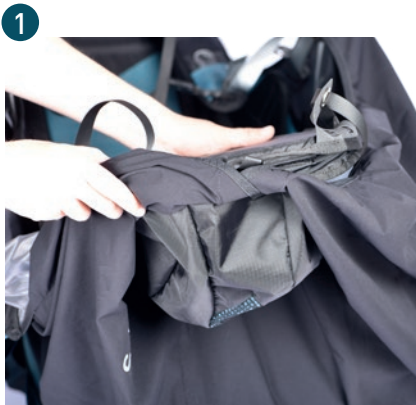

- 8 Verify the proper functioning of the speedbar by simulating the acceleration, that is to say by sliding out the string



Warning: make sure that the speedbar is not set too short. It could be dangerous. When you do not use the speedbar, the string should not be stretched at the risers.

ACCESSORIES ASSEMBLY

- 5 Pass the speedbar's string through the pulley on the side fabric of the harness as close to the seat as possible.
- 6 Pass the string through the welt opening on the side fabric of the speedbag.
- 7 Finally, attach the split hooks in order to connect the speedbar system to your glider.

INSTALLING THE RESERVE PARACHUTE



Thank you for reading the following carefully ! We recommend for the initial rescue parachute assembly and installation to be made by a qualified professional.

Reserve parachute folding and installation inside the harness must conform to the specific guidelines found in this manual. The volume of the rescue parachute may change depending on the packing. We have checked the compatibility of our rescue parachutes. Other rescue parachutes may be compatible, but you must ensure that the system works properly.

Main Container specifications



- Zipper + flaps locked by handle's cables
- Volume from 2.9 to 5.5 litres
- Adapted to the reserve parachutes SUPAIR SHINE, FLUID LIGHT and FLUID LIGHT EVO as well as other solo reserve parachutes.

DELIGHT 4 SPORT in S and M sizes			
Compatible parachutes	S	M	L
SHINE	✓	✓	*
FLUID LIGHT EVO	✓	✓	✓

DELIGHT 4 SPORT L and XL sizes			
Compatible parachutes	S	M	L
SHINE	✓	✓	✓
FLUID LIGHT EVO	✓	✓	✓

Folding the reserve parachute in its pod



Warning: the DELIGHT 4 SPORT S & M must be used with a S/M reserve parachute pod the DELIGHT 4 SPORT L & XL must be used with a L/XL reserve parachute pod

- 1 The reserve parachute must be set in the DELIGHT 4 SPORT specific pod. Prepare the reserve parachute next to the pod in order to transfer it.
- 2 Open the original reserve parachute pod



INSTALLING THE RESERVE PARACHUTE

- 3 Reform the folding in the DELIGHT 4 SPORT pod respecting the rectangular shape of the pod



- 4 Store the reserve parachute lines in the pod at the opposite side of the handle.



- 5 Using the cable included in the harness repair kit, close the pod through the gommets in the correct order as follows:



INSTALLING THE RESERVE PARACHUTE

- 6 Pass the lines in the loop to lock the pod opening.



- 7 Verify the final installation.



Reserve parachute/risers

A Access to the parachute attachment points

To access to the parachute attachment points, open the riser guide zipper, starting from above the left shoulder.



We recommend to use the risers delivered with the harness in order to guarantee an optimal opening of the parachute

B Connecting risers to harness thanks to lark's head.

1 Connect each riser to its attachment point by using a lark's head knot. Use the end with the largest strap loop.



INSTALLING THE RESERVE PARACHUTE

2 proceed the same way for the second attachment point.



3 Tighten each knot.



4 Make sure the final position of the risers is similar to the following illustration:



INSTALLING THE RESERVE PARACHUTE

One (1) square 7mm Maillon Rapide® will be needed + two (2) flexible toric rings.

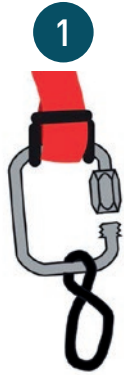

- Open the 7mm square Maillon Rapide®
- Push the maillon through the risers loops
- Push the maillon through the plastic ring
- Twist



- Push the two riser ends through the toric ring loop.
- Push the maillon through the riser loop.



- Give a second twist to the plastic ring.
- Push the buckle through the maillon.



- Tidy up the assembly.
- Be certain for the riser end loops to be securely fastened.
- Close the Maillon Rapide® tightly by hand.
- Tighten using pliers and making a ¼ turn.



Make sure the final position is similar to the following illustration:



INSTALLING THE RESERVE PARACHUTE

Installing the parachute in the container



Thank you for reading the following carefully ! We recommend for the initial rescue parachute assembly and installation to be made by a qualified professional.

Reserve parachute folding and installation inside the harness must conform to the specific guidelines found in this manual. We do not accept any liability for any other use.

- 1 The reserve parachute must be set in its pocket with risers oriented towards the harness back and with the reserve parachute handle at the opposite.

- 2 Place the reserve parachute in the parachute pocket respecting the orientation given in the previous step. Make sure the reserve parachute is properly installed at the bottom of the pocket.

Reserve parachute handle



INSTALLING THE RESERVE PARACHUTE

- 3 Take the zip slider at the very bottom of the zipper. Only the handle is sticking out.



- 4 Take the zip slider halfway up. The bottom of the parachute pocket should now be closed.



INSTALLING THE RESERVE PARACHUTE

- 5 Pass the first handle cable (on the left on the illustration) in the 3 loops located on the zipper. Make sure that the cable is inserted all the way through.

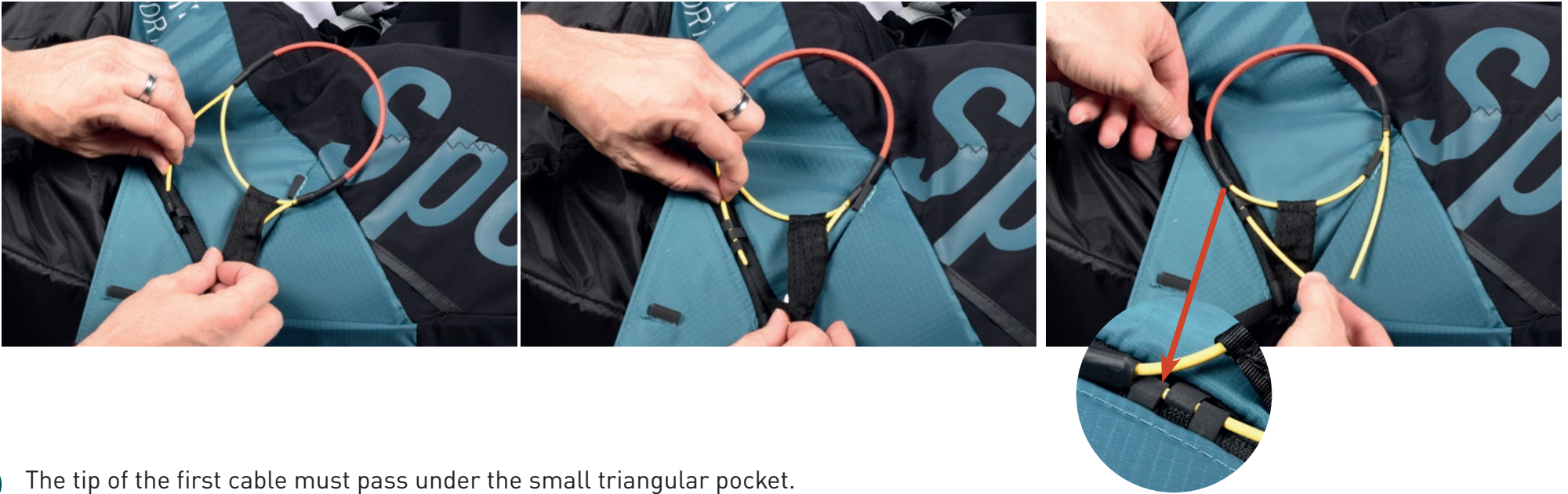

- 6 The tip of the first cable must pass under the small triangular pocket.



INSTALLING THE RESERVE PARACHUTE

- 7 Pass the second cable in the loop located on the edge of the triangular pocket. Once again, make sure that the cable is inserted all the way through.



- 8 Fold down the flap to insert it in the triangular pocket.



INSTALLING THE RESERVE PARACHUTE

- 9 Once the flap is folded down into the pocket, pass the second cable through the last loop under the flap.

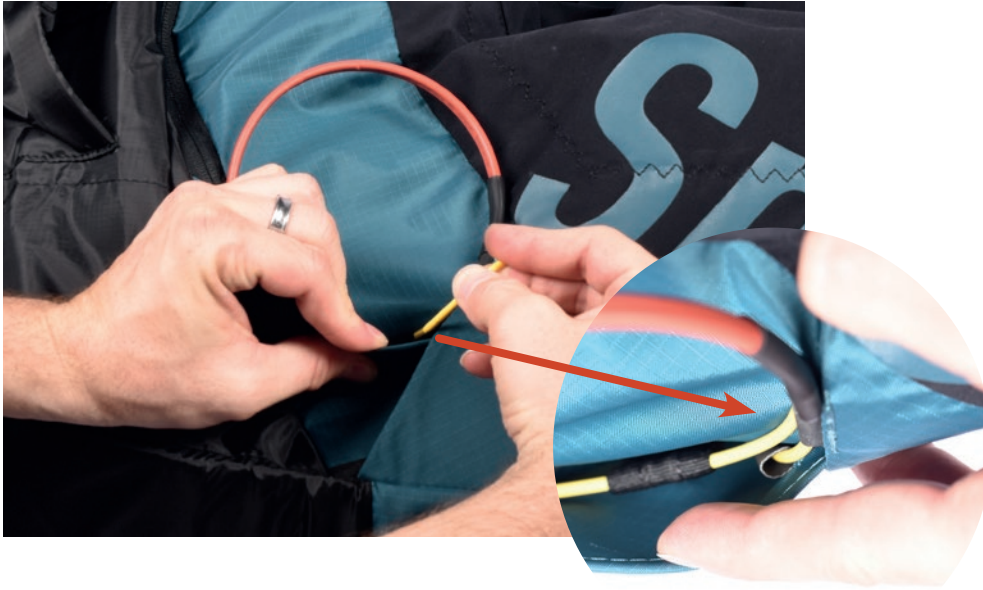

- 10 The reserve parachute handle is now installed. Make sure that your installation is similar to the following illustration:



INSTALLING THE RESERVE PARACHUTE

- 11 Take the zipper all the way up until the left shoulder.



The installation of the rescue parachute is now complete.

Mandatory extraction test procedure



Check the completed installation during a hang-test.

Have the installation checked by a professional outfit.
Conduct an extraction test every six (6) months to ensure proper system functionality.

Note :
Conducting and extraction test does not imply deploying the reserve parachute which will stay inside its pod.

STORAGE & TIPS



HARNESS FOLDING TIPS

Compact folding:

1 Put the harness on its back.



2 Fold down the seat.



3 Open the BUMPAIR main zipper.



4 Unfold the BUMPAIR.



5 Open the cockpit in order to flatten it before putting it at the center of the harness.



6 Fold down both edges of the harness and pass the shoulder straps over the BUMPAIR.



HARNESS FOLDING TIPS

- 7 Fold down the coverleg by inserting the foot plate between the seat and the back.



- 8 Turn the harness over with the foil facing up.



- 9 Open the back pocket.



- 10 Store the foil into the backpocket.



- 11 Pass the shoulder straps over the coverleg. Use the chest strap to lock the folding.



On takeoff, be careful not to jam the speedbar between the two parts of the BUMPAIR when folding and closing the protection. This would make the speedbar unusable during flight.



Adjusting the harness before each takeoff is vital.

Various adjustment

- 1 Adjusting the chest strap
- 2 Adjusting the shoulder straps.
- 3 Adjusting the backrest.
- 4 Adjusting the coverleg



HARNESS ADJUSTEMENT

Back inclinasion:

- Tightening will bring the backrest at a more vertical angle (recommended posture for beginners).
- Releasing the backrest will tilt the back support rearward.

← Loosening



Tightening →



Adjust the shoulder straps length using the trimmers.



The pressure on the shoulder straps contributes to general comfort in flight. It must be precise: not too tight nor too loose. The upper area of the straps must offer enough support to maintain your chest in a comfortable position.

← Loosening



Tightening →



Belly strap adjustment :



The distance to consider corresponds to the length between the middle points at the bottom of each carabiner.
The ideal distance varies between paragliding wing models.
Adjust your chest strap according to the recommendations of your paraglider manufacturer.

← Loosening



Tightening →

Tightening the chest-strap provides more stability but less piloting efficiency while increasing the risk of riser twisting.
On the contrary loosening the strap provides more efficiency but can be dangerous in turbulent aerology (increased risk of falling towards the collapsed side of your glider).

Lumbar support:

This setting allows to adjust the back support as much as you want.
The tighter the setting, the more lying the flight position. If you loosen this setting the position will be more upright.

Speedbag adjustment

Speedbag length:

Your legs must be stretched, sit to the bottom of the harness.



- 1 Adjust the foot-tip strap
- 2 Adjust the heel strap



If the setting is too long or too short, move the attachment points.

Once the adjustments have been made correctly, lock the strap through the double loop to prevent the adjustments from moving.



if the harness leans forward:

- the speedbag adjustment is too long
- the back support adjustment is too short



if the harness leans backward:

- the speedbag adjustment is too short
- the back support adjustment is too long

RESERVE PARACHUTE/RISERS

Connecting harness/risers

Without twisting the risers, connect them to the harness attachment loops using the self-locking carabiners.

Check for the risers to be properly positioned and untwisted. The «A» risers must be located at the front and facing the flight direction (see diagram).

Lastly, check for the main self-locking carabiners to be fully closed and locked in place.



Edelrid FORAS carabiners

Flight direction →

Connecting speedbar

Install the speedbar by following the instructions found previously.

Connect it to the wing using the split hooks.

Once the speedbar is connected, adjust its length according to your measurements.



For correct use, there must not be any tension at the split-hook level when the speedbar line is fully relaxed.



GETTING INTO THE HARNESS

1 Put on the shoulder straps.



2 Close the left loop of the belly strap.



3 Close the right loop of the belly strap.



4 Pass the anti-fall clip through the red loop.

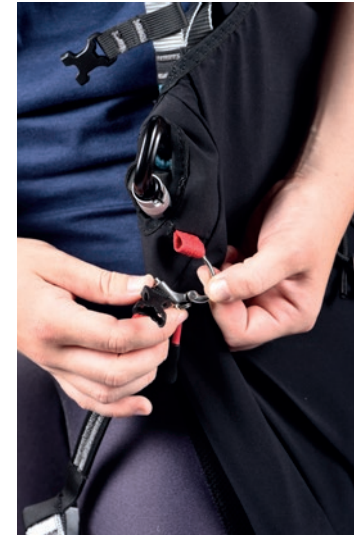

5 Close the anti-fall clip.

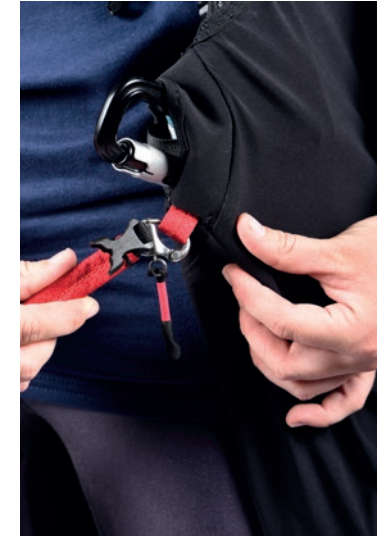

6 Close the right clip of the speedbag.



7 Close the cockpit clip.



8 Close the left clip of the speedbag.



9 Close the chest strap clip.



Optional parts:

- 1 Cockpit extension
Ref.: COCREHAUSSE



- 2 Carbon footplate

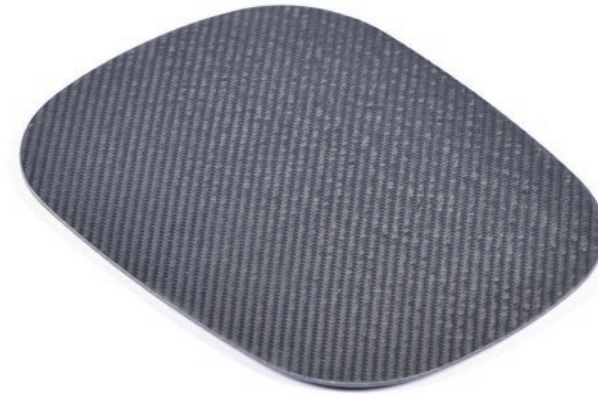

CARBON FOOTPLATE:
S/M size: MPPL010
L/XL size: MPPL024

Spare parts:

- 1 Anti-perforation mylar

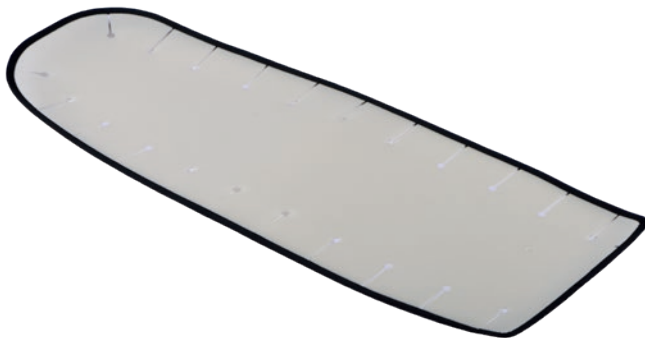

- 2 Scoop mylar

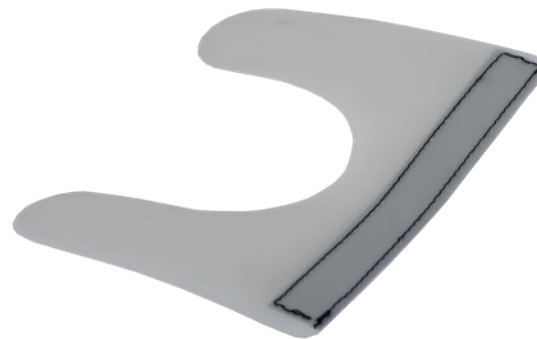

- 3 Carbon seatplate



MINI CARBON SEATPLATE:
S/M size: MPPL021
L/XL size: MPPL025

SPARE PARTS

- 4 Handle and pod
Ref.: S/M : POID4SSM
Ref.: L/XL : POID4SLXL



- 5 3B Speedbar
Ref.: ACCEL3BSTD

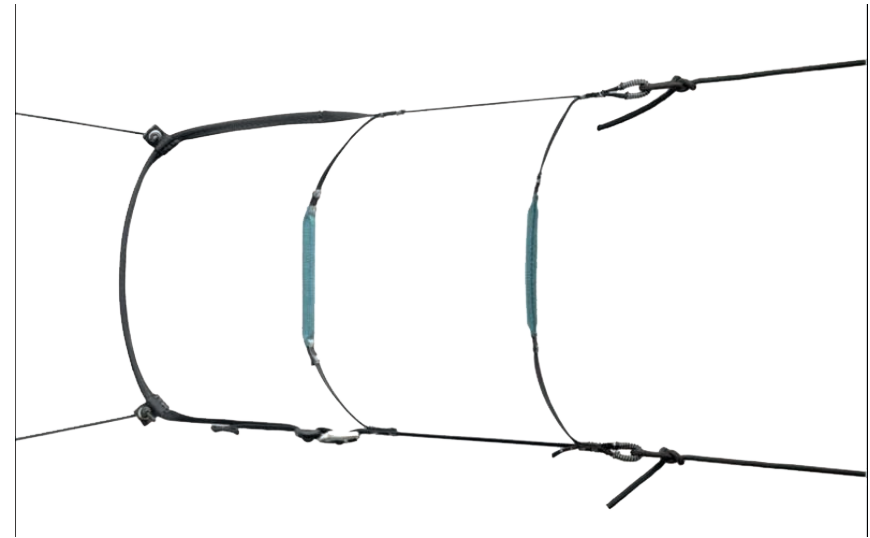

- 6 Polypro seatplate



POLYPRO SETAPLATE D4SP S/M MPPL038
POLYORO SEATPLATE D4SP L/XL MPPL025

- 7 BUMPAIR DELIGHT 4 SPORT protective foam



BUMPAIR DELIGHT4
Ref.: PROBUMP4S

REPAIR KIT

What is it for ?

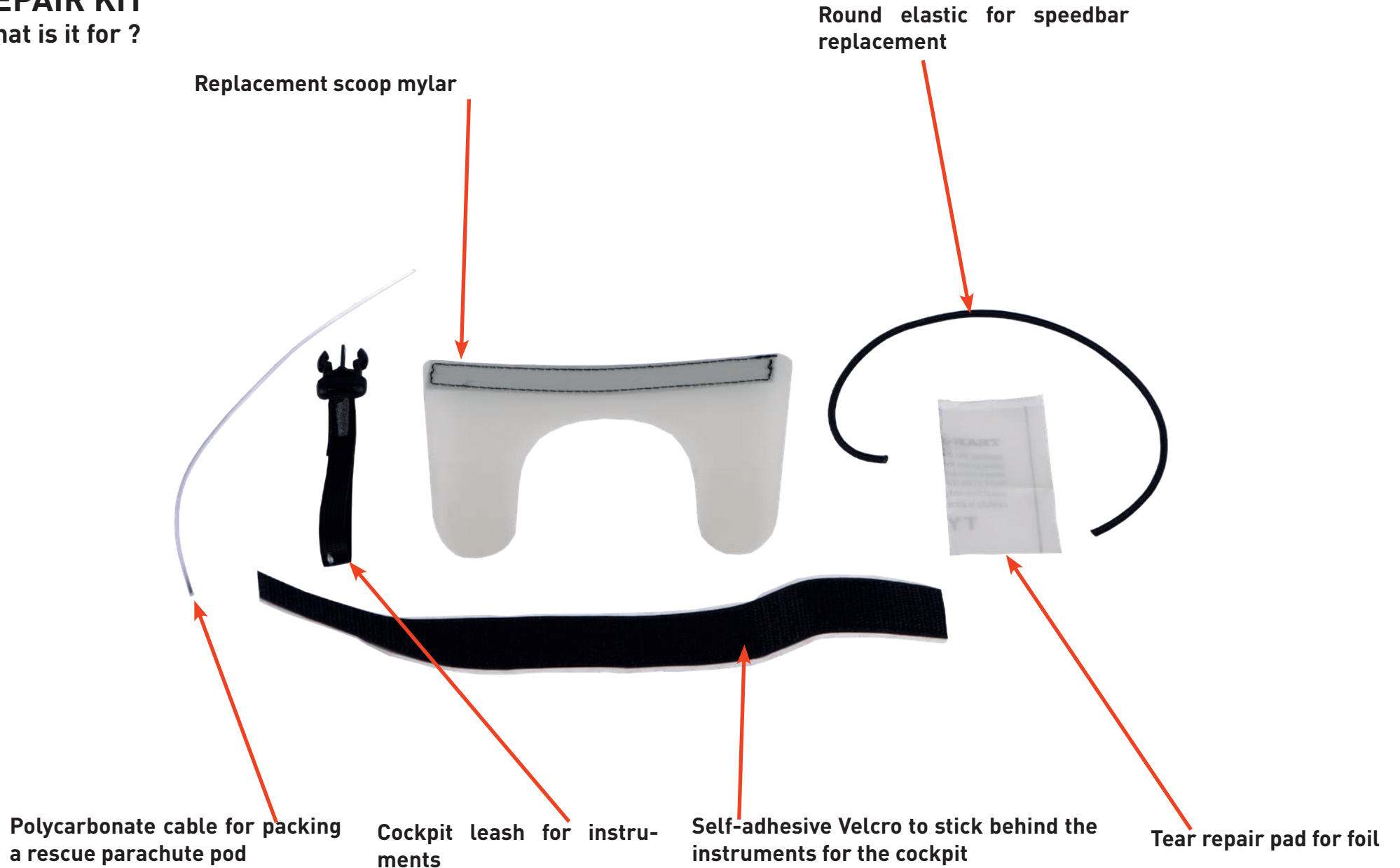

INFLIGHT BEHAVIOR

The fourth generation of the DELIGHT in its sport version it is in line with its predecessors: a performant, comfortable and ensuring harness.

On takeoff, the lightness of the DELIGHT 4 SPORT offers an excellent mobility in order to ensure an easy and intuitive piloting on the ground

In flight, its stable and reassuring behavior is inspired from the DELIGHT 3 and STRIKE 2. The harness filters the air mass to only communicate the right information for precise and comfortable piloting. Modifying the beld strap length influences the stability of the DELIGHT 4 SPORT and it allows to adapt to the preferences of each pilot.

The DELIGHT 4 SPORT is designed to be piloted in a sitting or half-laid position. Therefore, the harness is adapted for both experienced pilots and pilots looking for an accessible and easy-to-use first cocoon.

The DELIGHT 4 SPORT allows you to exploit the full potential of your wing throughout the flight.

The back structure is more rigid than the DELIGHT 3 and improve the comfort during accelerated flight, which makes cross country flights easier and more comfortable. The DELIGHT 4 SPORT also differs from the DELIGHT 3 by the presence of its foil which makes it more stable on the yaw axis. Its in-flight adjustments make it an easy-to-use and comfortable harness at all times.

Performance, comfort and simplicity make the DELIGHT 4 SPORT the ideal harness for cross country flying !

The harness can be flown in a sitting position, with the legs bent, it remains maneuverable and allows you to deal with turbulent conditions and to manage a possible flight incident in an optimal way.

To discover your new harness, we advise you to fly with it for the first time with your usual wing, in calm conditions and on site you know well.



Pre-flight control



- Check that the harness and the carabiners are not damaged
- Make sure that the reserve parachute safety cables to ride through the closing tabs keeping the reserve rescue pocket flaps closed.
- Check that your personal settings haven't changed.
- Check that all zippers and buckles are closed.
- Check that the speedbar is correctly connected and set up.
- Check that no rigging line or other object comes in contact with rescue parachute handle.
- Make sure that the self-locking carabiners are locked and connected to the paraglider.

take-off

After a thorough weather conditions analysis, when the decision to fly has been taken, put your harness on and follow the next steps:



- Fully close the chest strap buckles.
- Close the Speedbag closing buckle to the right side.
- Close the Speedbag closing buckle to the left side.

During takeoff, maintain a standing posture and grab the Speedbag with one of your heels once far enough from the ridge. Using the foot-rest, push yourself inside the harness.. With help of the foot-rest, push yourself back into the harness. The Speedbag closes and the Cockpit positions itself automatically.





Do not release your hands from the brakes when you are close to terrain.

In flight

 **Once in flight, the DELIGHT 4 SPORT behaviour is intuitive and stable. Please set the distance between the two carabiners according to aerology and to the wing manufacturer's recommendations.**

Speedbar use

 We recommend a cautious speed-bar use due to the increased risk of major partial or full frontal collapses. Use the speed-bar/accelerator (transitions) only when far away from the ridge and in calm weather conditions as the wing becomes more sensitive to turbulence when accelerated. If you feel a loss of tension in the speed-bar/accelerator, stop pushing it and apply a light brake pressure on the toggles to prevent the glider from experiencing a potential frontal collapse.

 To properly use the speed-bar, keep one foot at the foot-rest center space, and push with the second foot on the first speed-bar to obtain a symmetrical acceleration. Use one foot for the first stage and the other for the second stage. To decelerate, stop pushing and gradually release the accelerator/speedbar tension.

Landing

 When making a landing approach, take your legs out of the Speedbag well in advance. Stand up inside the harness and adopt an upright position in order to run and dissipate the horizontal speed. Always be certain to have enough altitude to make a landing approach corresponding to the weather conditions of the moment and terrain. During the landing approach, never make hasty maneuvers. Always land upwind in a standing posture and be ready to run upon touchdown if necessary. During high wind speed landings, turnaround and face the wing as soon as ground contact is made and move toward the wing while braking symmetrically to deflate it.

Do not land in a seated position as it is dangerous.

USING THE RESERVE PARACHUTE

Throwing the reserve parachute



It is strongly recommended to frequently check your reserve parachute handle location while in flight. This exercise should be executed instinctively and will increase your chances of a successful parachute extraction in case of an emergency. Estimate your AGL (Altitude Above Ground Level), which if high enough may make it worth trying to bring your wing back to a normal flying configuration. If in doubt, quickly deploy your emergency parachute.

Deploying a rescue parachute should be done only in an emergency.



With a strong, lateral and then vertical tug, pull the handle towards you and then throw the parachute away from you (including the container and its handle) toward a clear unobstructed area of the sky. As soon as the parachute deploys, bring as much of the glider as possible toward you by pulling as symmetrically as possible on the "C" or "D" risers or on the toggles/brakes. Be prepared to land by adopting an upright position, with knees together and legs slightly bent. Prepare to roll down with pivoting shoulders in a paragliding fall (PLF).

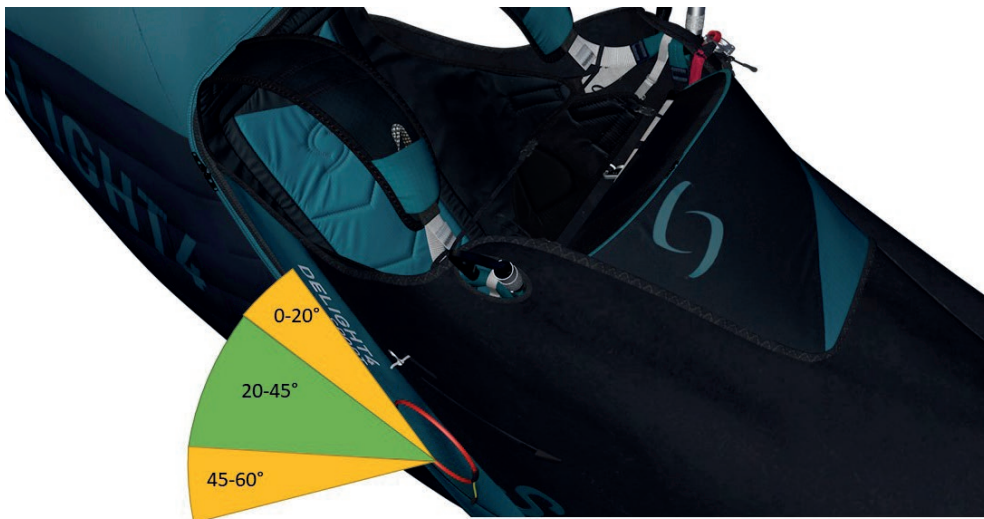

The best way to extract the reserve parachute is to pull the rescue outwards at an angle of 20-45°. Between 45-60°, extraction may require additional effort.

As you use the reserve parachute, regroup your body in the harness by straightening forward and bringing your legs under the harness.

Train regularly under hanging device for your own safety.

TOWING

To takeoff under tow, you must be equipped with a quick release specially designed for the task.

Connect the tow bridle to the wing riser loops with a Dyneema adaptor with a resistance greater or equal to 300kg. The tow bridle will then be fastened by using a lark's head knot or an adapted metal link.

To complete the installation, follow the tow bridle reales manufacturer's recommendations.

MANDATORY CONTROLS

Mandatory biannual inspection :



- Ascertain parachute deployment functionality by pulling the handle to activate a clean pod extraction sequence
- Inspect the harness for wear and tear.

Annual check :



An annual deployment and repacking of the reserve parachute must be conducted by competent and certified personnel.

Harness cleaning and maintenance

It is a good idea to clean your harness from time to time. We recommend using a brush and soft solvents only (soap or mild cleaning agents). Rinse thoroughly. Never use aggressive chemicals such as strong solvents which could be harmful to the harness's fabric, webbings, stitching and weaken its integrity.

The zip fasteners should be lubricated from time to time, using a silicon spray.

If you regularly use your harness in a dusty environment (dirt, sand, etc...), we advise you to regularly check and maintain your carabiners and buckles : clean them with a mild detergent, then blow dry them fully but **DO NOT LUBRICATE !**

Prior to using them, conduct a thorough carabiners and buckles checkup to insure their full functionality.

If you use your harness in a marine/sandy/salty environment, pay particular attention to your gear and follow a rigorous care/maintenance routine.

Storage and transport

When not in use, your harness should be stored inside your paragliding backpack, in a dry, cool and clean place, protected from UV exposure. If your harness is wet, please dry it thoroughly before storing.

For transport, protect the harness from any mechanical or UV deterioration (use a bag). Please avoid long transports in wet conditions.

Life span



- Once every two (2) years, a thorough harness inspection must be conducted :
- Webbing wear and tear (no excessive wear, no rip beginning, no unwanted folds)
- Buckles and carabiners (functionality, wear and tear).



BUMPAIR dorsal protector damage after substantial impact(s). It must be replaced by a new one after two (2) substantial impacts or five (5) years of use (whichever comes first). The threads and fabric used for the manufacturing of the DELIGHT 4 SPORT were specifically selected

for their quality and resilience levels. However, in particular instances such as long term UV exposure, abrasion, contact with damaging chemicals, general wear and tear, the harness will need to be inspected at a professional certified repair facility. Safety comes first!



The self-locking carabiners are NEVER to be used for any activities other than paragliding

Independently of the pre-flight check-out, you have to open and unfold your rescue parachute once every year.

Repair

In spite of using the highest quality products to manufacture the DELIGHT4 SPORT, it is possible for your harness to deteriorate through general use. If showing any sign of wear and tear, it should be sent for inspection and/or repairs at a professional certified facility.



SUPAIR now offers an extended warranty period reaching beyond the product standard protection plan against manufacturing defects. Please contact us either by telephone or by E-mail sav@supair.com in order to receive a quotation.

Hardware & Parts

Fabrics

- Ripstop duraford robic
- Aquatech light stretch
- Skytex 38G
- Taffeta 50D

Straps

- Dyneema Polyester 25mm
- Straps Polyester 15mm
- Straps Polyamide 20mm

Recycling

We have minimized our manufacturing footprint by carefully selecting environmentally friendly materials.

If you estimate that your DELIGHT 4 SPORT has reached the end of its life span, you can separate plastics from metals and recycle them according to your community rules in effect. As for the fabric itself, contact your local authorities to find out how to proceed to discard it.

WARRANTY

SUP'AIR takes the greatest care in its products design and manufacturing and hence offers a five (5) year limited warranty from the date of purchase against manufacturing defects or flaws occurring during normal use. Any damage or degradation resulting from incorrect or abusive use, abnormal exposure to aggressive factors, including, but not limited to; high temperature, intense sun exposure, high humidity etc, will invalidate this warranty. The provided safety protections in the SUPAIR harnesses are guaranteed for use in medium temperature (between -10°C and 35°C). The protections lifespan is 5 years or limited to 2 consequent shocks. If an airbag is used instead of foam, check that it is correctly installed.

DISCLAIMER



Paragliding is an activity requiring specific skills and sound judgement. Learn how to fly within the environment of a certified paragliding school. Carry an insurance policy with you in addition to your pilot certification. Always mind and gauge your personal skills relative to the elements you want to be flying in. Better be safe than sorry ! SUP'AIR can not be held responsible for your paragliding decisions or activities.



This SUP'AIR product has been designed exclusively for paragliding. Any other activity such as skydiving or BASE jumping is absolutely forbidden.

PILOT'S GEAR



It is essential for you to wear a suitable head protection (certified paragliding helmet), boots and right clothing for the activity. Moreover, carrying a reserve parachute connected to your harness in flight is highly recommended.

BUMPAIR DELIGHT 4 SPORT shock absorber

The harness you have just purchased has a AIRBAG type shock absorber. This protection is intended to protect you against potential impacts. It complies with EU Regulations 2016/425 relating to personal protective equipment (PPE) and certified by expert following protocol CRITT-SP SL-003 09/2021.

The shock absorber UE conformity of your harness is certified by the following laboratory: ALIENOR CERTIFICATION n°2754 ,Z.A. du Sanital, 21 Rue Albert Einstein, 86100 Chatelleraut, FRANCE. The test reports and the EU Declaration of Conformity are available at:

supair.com/telechargements/

The storage, transport and maintenance of the AIRBAG is the same as it is for the harness. The inspection of the protector is the same as it would be for the harness.



Please note that no shock absorber can guarantee total protection against injury. The back protector does not prevent potential injuries to the spine and/or pelvis. In addition, only the parts of the body covered by the shock absorber are likely to benefit from adequate protection against possible impacts.



Please note that the performance of the equipment can be dangerously affected by any modification made or improper use of the shock absorber, and negatively affect the proper functionality of the protector which must be whole and properly installed. You must check that all is in order prior each flight:

- 1 / The correct shape and inflation of the AIRBAG/shock absorber.
- 2 / The AIRBAG seams and overall condition of the fabrics - look for holes, tears, snags



The protection can have a five (5) year lifespan under normal use conditions.
Warning! Following a major hard landing the protector can be damaged.

Transport:

The transport and maintenance of the BUMPAIR is the same as for the harness. The revision of the shock absorber is also the same as that of the harness. The BUMPAIR must be stored in an uncompressed state.

Maintenance and controls:

Have your protection checked once a year. If your shock absorber is damaged, have it professionally assessed and repaired or contact us at sav@supair.com. For disinfection, please contact sav@supair.com

Lifetime:

The shock absorber may have a maximum life of 5 years under normal use. Caution: Following an exceptional event such as a major shock, the shock absorber may be discarded after the first use.

Storage and cleaning:

Store your protection in a dry, ventilated area at room temperature and not compressed. It must be cleaned only with water.

If your shock absorber is damaged, have it professionally tested and repaired or contact us at sav@supair.com. Test reports and the EU Declaration of Conformity are available at: www.supair.com



- Complies with EU regulation 2016/425
- Certified by expert opinion according to protocol SP-003 09/2021
- The EU declaration is available on the website www.supair.com
- Certified by ALIENOR CERTIFICATION n° 2754 ZA DU SANTAL 86100 CHATELLERAULT France

PPE manufacturer:

SUPAIR SAS
Parc Altaïs, 34 rue Adrastée,
74650 CHAVANOD
FRANCE

Communicate in case of accident

Emergency numbers 

EUROPE / INDIA	112
USA / CANADA	911
CHINA / JAPAN	119
NEPAL	101
IRAN	112
AUSTRALIA	000
NEW ZEALAND	111

Need help?

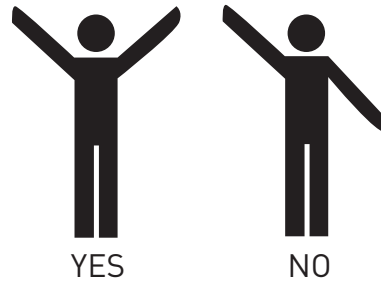

Light SOS :



MAINTENANCE BOOKLET

This page will help you keep record of your ACCESS2 BUMPAIR scheduled maintenance.

Purchase date:	
Owner's name :	
Name and stamp of the store :	

<input type="checkbox"/> Care	
<input type="checkbox"/> Resale	
Date	
Name of the workshop/purchaser	

<input type="checkbox"/> Care	
<input type="checkbox"/> Resale	
Date	
Name of the workshop/purchaser	

<input type="checkbox"/> Care	
<input type="checkbox"/> Resale	
Date	
Name of the workshop/purchaser	

<input type="checkbox"/> Care	
<input type="checkbox"/> Resale	
Date	
Name of the workshop/purchaser	

MANUAL

COBRA® COMPONENTS

The COBRA® components by AUSTRIALPIN are intended for usage in fall arrest, PPE (personal protective equipment) products, and load security systems (including, but not limited to, harnesses). This COBRA® component must not be used beyond its specific limits, and must be used only for the purpose for which it was designed.

Activities in the heights, for which these COBRA® components are intended as part of a fall protection system, are by nature dangerous. Errors, recklessness or inattentiveness can lead to life threatening injuries or death.

You yourself are responsible for your own actions and decisions. The following instructions for use must be read carefully and thoroughly, understood and followed. They contain important information about certain dangers and risks associated with the use of this COBRA® component. However, it is not possible to outline and describe all potential dangers and risks. These instructions must be kept safe and easily accessible for the entire life and use of this COBRA® component. Re-sellers must provide these instructions to the buyer in the appropriate language.

Manufacturers using this COBRA® component in their products are responsible for the correct and orderly installation. Moreover, they must attach the following instructions to the product or include them in the corresponding manual/operating instructions of the product. In case of misuse or improper application, AUSTRIALPIN rejects and rules out any and all liability

NAMES OF PARTS (ILLUS. 1)

COBRA® Quick Release

(1) Body consists of (a) female part (b) male part; (2) adjuster bar (optional); (3) integrated D-Ring (optional); (4) rivets; (5) clips

COMPONENT MARKINGS

on upper side:

- AUSTRIALPIN: name of manufacturer

on lower side:

- Made in or ORIG.: country of origin AT (Austria)
- batch number multi-digit
- buckles marked with «ANSI»: 4-digit number (year of manufacture) 1-digit (batch number) optionally on upper side:
- COBRA®: name of component group. (see illus. 8)
- kN: breaking load straight pull in kilonewton
- kN: breaking load loop configuration pull in kilonewton
- kN: breaking load of D-Ring straight pull in kilonewton
- PAT. or PAT. PEND: patented or patent applied for
- MOD. DEP.: note of patent on design
- ANSI Z359_: Norm to which component corresponds
- OUL: open under load – buckle can be released while under load
- NO PPE or DO NOT USE FOR FALL PROTECTION: do not use for personal protective equipment
- INDIVIDUAL TST: individual article tested

MATERIALS

Body: aluminum

Rivets, adjuster bar, integrated D-Ring: stainless steel

Clips: brass

Anti slide part: polymer

Material exceptions:

- item no. starts with «FI»: stainless steel body
- item no. starts with «FT»: steel body
- item no. contains «VA4»: 100% stainless steel
- adjuster bar COBRA® FM and COBRA® FZ: aluminum
- adjustment valve SUPER COBRA®: aluminum

COMBINATION; USING TOOLS AS A SYSTEM; COMPATIBILITY

By combining this component with others, the safety features of each component can interfere with each other. Assure yourself of their compatibility. An incorrect combination of components can bring about unintended and unforeseeable dangers, in which case the safe functioning of a given component is no longer guaranteed. The compatibility of connecting components and harness straps must be ensured by the harness manufacturer. The operating instructions of each product must be heeded carefully, in particular those of the catching system, of which this connecting component forms one part.

SIZE

Use the COBRA® components only with corresponding harnesses. A tolerance of ± 3 mm is webbing size of the component name (as designated on the delivery note or invoice) or request this information at office@australpin.at.

INCORPORATION IN THE HARNESS SYSTEM

a) Make allowance for the correct position of the harness component in its closed state. The upper side must be the side turned away

from the body. You can recognize the upper side from the lettering AUSTRIALPIN and/or COBRA®. b) For COBRA® components with adjuster bar or middle bridge only: Make sure the strap is correctly threaded through the adjustment mechanism. If the functioning of the harness system permits, sew the end of the strap in such a way that it is impossible to become unthreaded (see illus. 7). c) For multiple-part COBRA® components only: The individual parts must be ordered in the correct way so that when connecting, each upper part is turned away from the body.

THINGS TO CHECK BEFORE, DURING AND AFTER EACH USE

Make sure that the COBRA® component has no cracks, deformations, fractures, fissures or signs of corrosion and that all components are firmly attached to each other.

FOR COBRA® BUCKLES (CLICK-CLOSURES) ONLY

Make sure that the male part and the female part belong to the same component group. (table 1) Check the riveting and the perfect functioning of the clips. Make sure that the buckle closes tightly and securely. Ensure both before and during usage that the buckle is correctly closed. Combine only COBRA® Buckles with the same type; for example FY with FY; FX with FX, FT with FT, etc. Do not use COBRA® components marked with -OUL (open under load) for PPE products.

XPERT CHECK

Quite apart from continuous checking before and during use, the COBRA® components and the overall product must be checked, tested and verified at least once annually by a professional. The product should ideally be used only by one person so that the overall history of the product usage is known. Record the date of its first use. In case products are used by several persons, we recommend a systematic checking and documentation before and after each use.

OPERATING INSTRUCTIONS

General: Always pay close attention to correct alignment, especially the way the COBRA® component are pointing. The upper side must face away from the persons body.

COBRA® buckles:

Open: Press both clips simultaneously.

Close: insert the male part into the female part without exercising the clips. A click sound should be audible from both clips. By pulling on it shortly, test whether the buckle is really closed.

Adjuster bar / Middle bridge: it is possible to adapt the length of the harness with the adjustment mechanism. Take care to backthread the strap correctly (see illus. 7).

If the ends have not been suitably sewn closed by the manufacturer, the harness can come unthreaded. Make sure that the harness does not unintentionally slip out.

CLIMATE FOR USE

The use temperature of the COBRA® component (dry) is from about -80°C to +80 °C.

LIFESPAN

Lifespan of the COBRA® component is largely dependent on the ways it is used and the frequency with which it is used, together with other external influences. Maximum lifespan in optimum storage conditions and without use is 15 years. Maximum life of use as of its first deployment is 10 years. The actual lifespan of the COBRA® component ends when one of the following criteria for end-of-use becomes applicable (see point End of Use) and depends on various factors: intensity of usage, frequency of usage, environment of usage and user competence, storage conditions, care and maintenance, etc.

Unusual circumstances can reduce the component life of an element to a one-time usage, e.g. contact with chemicals, extreme temperatures, salty or acidic atmosphere, sharp edges, extreme loads.

END OF USE

In the following cases, the equipment should immediately be removed from active use:

- The equipment fails to pass the check-test (both before each usage, during use and in regularly conducted test examinations).
- The equipment has been subject to heavy, high burdens (unless perfect and assured use can be verified by a professional person).
- The history of its use is unknown or incomplete.
- In case damages, deformation, cracks or stark abrasion of the metal parts are observed.
- You have doubts about the reliability of the equipment.
- The component is too old (or legal requirements have changed, norms and technical standards have been altered, new rules are introduced, incompatibility with other products is determined, etc.)

For COBRA® buckles only:

- The clips for opening the buckle do not operate or do not operate easily despite thorough cleaning and lubricating; or after having been used do not return to the original position.
- The buckle does not close correctly – the characteristic click-noise must be audible for both clips when closed.

Dispose and destroy the discarded parts immediately in order to prevent any further use by others.

ALTERATIONS AND REPAIRS:

If original parts of the COBRA® component are altered or removed, the safety features can be comprised. The equipment must not be altered or fitted with additional parts in any way which is not expressly recommended by the manufacturer.

STORAGE, TRANSPORT AND MAINTENANCE

Store your equipment in a dry state in a dry place protected from daylight at normal environmental temperatures (-10° to +30°C) where it is free of any mechanical compression, pressure or tensile load. Store the equipment away from chemicals, and away from an acidic or saline atmosphere. Avoid ongoing vibrations. Use the protective bag or special storage and transport containers with non-metallic bottoms (to prevent contact corrosion).

CLEANING

Clean dirty COBRA® components in lukewarm water (if necessary using neutral soap). Rinse them well. Dry at room temperature, never in an electric dryer or near electric radiators. Use only approved household disinfection liquids not any containing halogen as needed.

The joints of all metal parts must be relubricated with a dry lubricant regularly, particularly following cleaning (such dry lubricants perform their lubricating function even when in a dry state so that no dust or dirt can cling to it).

If the instructions for use are not heeded, life threatening dangers can result. Printing errors and omissions, as well as technical changes, are ruled out.

ANSI test carried out by UL LLC.

© AUSTRIALPIN GmbH

01/2019, Subject to printing errors and technical changes.

AUSTRIALPIN®

and COBRA® are registered trademarks.

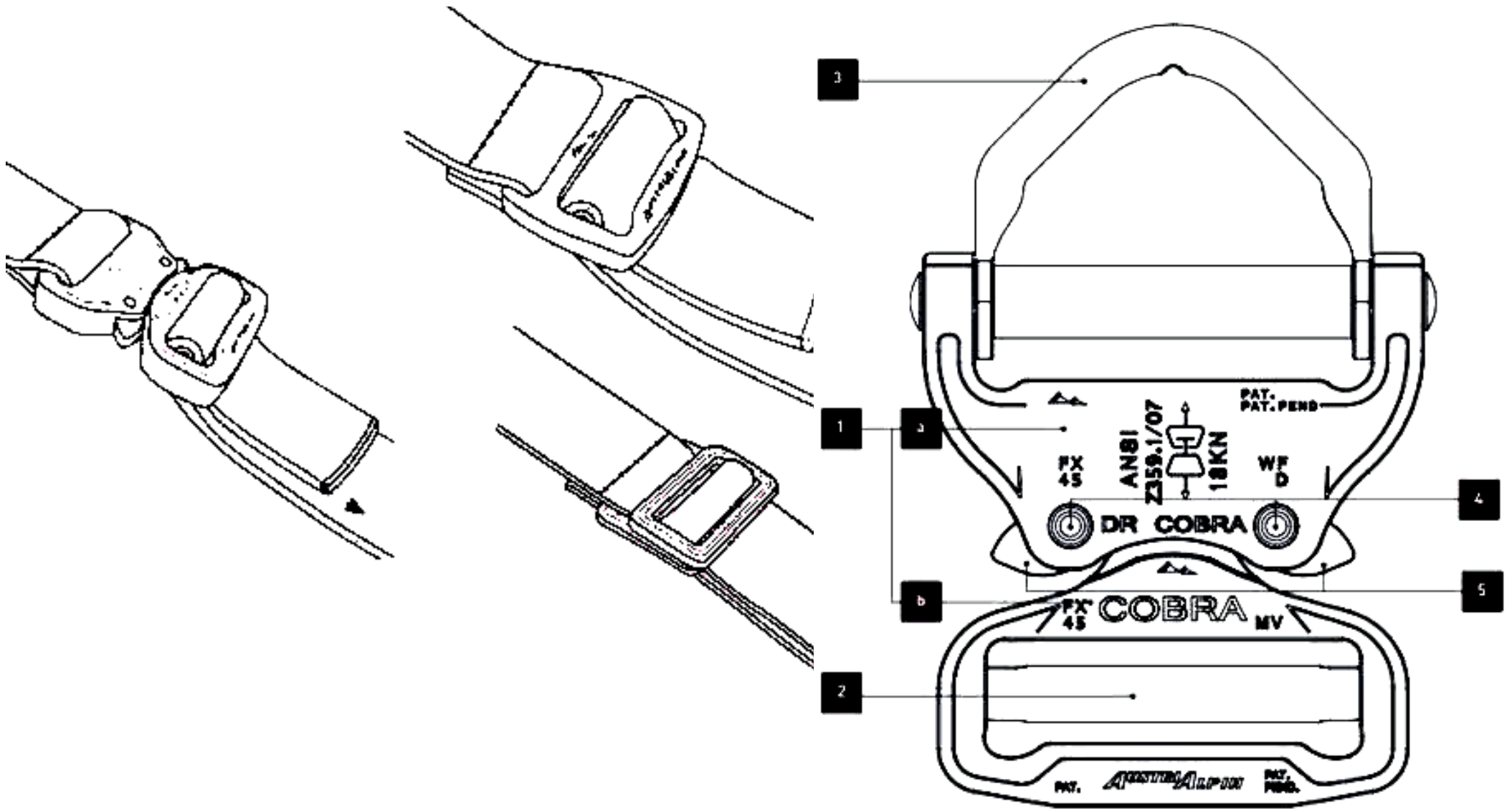



SUPAIR s.a.s
Parc Altaïs
34 rue Adrastée
74650 Chavanod, Annecy
FRANCE

www.supair.com
info@supair.com
+334 50 45 75 29

RCS ANNECY 387956790

■ ■ DESIGNED
■ ■ IN ANNECY

 100% MADE
IN EUROPE