

SKYWALK



PRO
GUIDE

MESCAL6

TABLE OF CONTENT

1	Introduction	3
2	Description	4
3	Technical Data	5
4	Line System	5
5	Acceleration System	7
6	Flight Techniques and Characteristics	7
7	Descent Techniques	11
8	Materials	12
9	Homologation	13
10	Closing Words	14
11	Line Schematic	15
12	Line Length	15
13	Risers	16
14	Overview Glider	17
15	Test Protocoll	18



1 INTRODUCTION

Welcome to skywalk!

Congratulations on the purchase of your new MESCAL6 and thank you for your trust in us and in our products. In this manual you will find product-specific information that will help you quickly get to know your new paraglider to ensure your fun for a long time. General information about the most important safety-relevant points for handling your paraglider can be found in the attached „BASIC GUIDE“.

We are always open for questions, comments or critique and are happy to provide you at any time with further information!

Your skywalk Team
 PURE PASSION FOR FLYING

Edition 1 /03_20
 The latest version of the manual can be found on
www.skywalk.info

2 DESCRIPTION

The MESCAL6 is a wing that is particularly easy to handle and gives you a lot of confidence from the first moment. You get a glider that is completely stress-free from pre-launch preparations to after-landing packing.

The MESCAL6 comes equipped with all the latest technologies, placing you at the cutting-edge right from the start.

PILOT REQUIREMENTS

The MESCAL6 is suitable for pilots of all abilities, from training to experienced leisure pilots. It offers maximum flying fun with the highest level of passive safety - at the practice hill as well as in strong thermal conditions. And of course, the MESCAL6 is fully suitable for training.

SCOPE OF DELIVERY

The MESCAL6 comes standard with inner bag, compression strap, glider backpack, riser bag and "BASIC GUIDE".



3 TECHNICAL DATA

Size	XXS	XS	S	M	L
Cell number	38	38	38	38	38
Area flat (m ²)	22,23	24,29	26,45	28,70	30,74
Wingspan flat (m)	10,30	10,80	11,30	11,70	12,10
Aspect ratio flat	4,80	4,80	4,80	4,80	4,80
Area projected (m ²)	18,73	20,48	22,30	24,19	25,92
Wingspan projected (m)	8,10	8,40	8,80	9,20	9,50
Aspect ratio projected	3,47	3,47	3,47	3,47	3,47
Min. profile depth (cm)	63	66	69	72	74
Max. profile depth (cm)	268	280	292	304	315
Middle line length without risers (m)	6,61	6,91	7,21	7,51	7,77
Line consumption (m)	266	278	290	303	313
Weight (kg)	4,3	4,6	4,9	5,2	5,5
Take-off weight from - to (kg)	50-75	65-85	75-95	85-110	95-135
Winch certified	yes	yes	yes	yes	yes
JET FLAP Technology	yes	yes	yes	yes	yes
Paramotor homologation	no	no	no	no	no
Accelerator	yes	yes	yes	yes	yes
Maximum speed bar travel (mm)	140	140	140	140	140
Brake line travel max. (cm)	64	66	69	73	77
Trimmers	no	no	no	no	no
Number of seats	1	1	1	1	1

4 LINE SYSTEM

The layout of the suspension points is designed for optimal load distribution and a long lifespan. With all considerations and calculations however, our focus is always on safety. The mix of materials used on the lines of the MESCAL6 is an ideal combination of durability, low stretch and low drag.

The skywalk MESCAL6 has 3 A-, 3 B-, 3 C-, and 1 stabilo line. The main-stabilo is connected with the B-riser. The brake lines are not load-bearing and lead from the trailing edge over the main brake lines through the brake pulleys on the C-risers to the brake handles. A marking on the main brake line indicates the position of the handle attachment. This setting should not be lengthened, for example, to provide more brake travel in extreme flight situations or during landing, nor shortened such that the glider is flown constantly with some brake on.

To provide a better overview and to make sorting easier, the lines have different colors:

- the A1, AII, AIII-lines and the A-risers are red.
- the B1, BII, BIII-lines and the B-risers are yellow
- the C1, CII, CIII-lines are blue.
- the stabilo lines are orange.
- the brake lines are orange.

The lines are attached with loops to oval shackles and secured with plastic inserts.

The skywalk MESCAL6 has 4 risers per side:

- the two inner A-mainlines lead to the inner A-riser, the outer A-line leads to the outer A-riser.
- the B-lines as well as the stabilo lines lead to the B-riser
- the C-lines lead to the C-riser

A schematic drawing of the risers can be found at the back of the manual.



5 ACCELERATION SYSTEM

The skywalk MESCAL6 can be equipped with a foot-operated acceleration system. The acceleration system effects the A, A2 and B-risers. Both risers are equipped WITHOUT trimmers. Exact lengths of the accelerated risers can be found on page 16.

6 FLIGHT TECHNIQUES AND CHARACTERISTICS

WINCHTOWING

The skywalk MESCAL6 is well suited for winch towing. Make sure that you only use certified winches and that you climb from the ground at a flat angle.

The pilot must have had proper towing instruction and must ensure that the winch operator has had proper training that includes paragliders. When launching on a winch, always fly with a lot of feeling and don't brake too much as your glider will already have an increased angle of attack. We recommend the use of a towing adapter.

FLYING WITH A MOTOR

Currently, the MESCAL6 has no certification for flying with a motor. You can find out the current status of motor certification at any dealer or importer, or by asking skywalk directly.

AGILITY SYSTEM

The MESCAL6 is equipped with the AGILITY SYSTEM. This system enables to convert between two brake line geometries – „Comfor-Mode“ and „Sport-Mode“. As standard the MESCAL6 is delivered in Comfor-Mode. For the conversion to Sport-Mode you only need to adjust the length of the brake top lines on the brake tensioning system. The brake lines don't need to be untied, you only need a rigid foil to conduct the conversion.

Conversion to Sport-Mode:

- Top brake lines br1, br2, br3 must be extended
- Top brake lines br4, br5, br6, br7, br8, br9 must be shortened

Note: Use the line scheme to find the position of the line.

On each wing half at the trailing edge, 9 pockets are sewn on the binding tape at the bottom sail. The excess length of the top line must be stowed in these pockets if the line must be shortened. If the line needs to be extended, the excess length is already stowed in this pocket and the loop only needs to be opened.

Follow these steps to **shorten** the line:

① The pocket is marked with the icon „Agility System“. This pocket is divided into a larger and a smaller half. Thread the metal ring out of the smaller one.

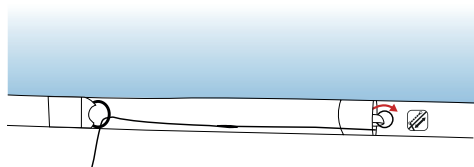

② A loop is spliced into the top line. You need to loosen this loop and the next step will be easier.

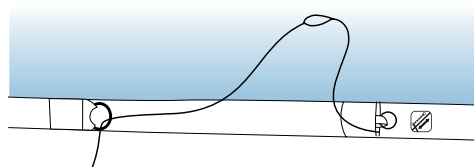

③ Now you have to guide the brake line through this loop. It is important that you use the line below the loop, which leads to the middle gallery lines. If you use the line above the loop, which leads to the pocket where the line is sewn, the knot may get loose.

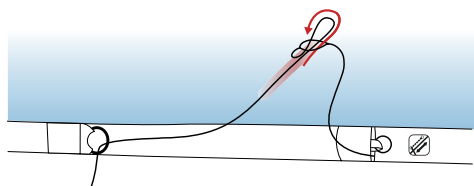

④ Place the new created loop around the metal ring and pull it firmly.

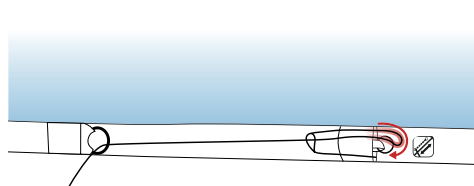

⑤ Thread the enclosed rigid foil through the loop of the excess brake line. Afterwards you need to thread the rigid foil through the larger pocket and pull it firmly that the loop disappears in the pocket.

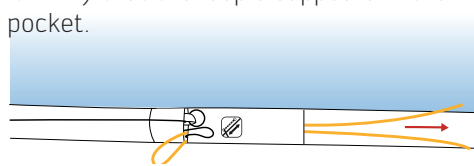

⑥ The brake line is now shortened. Stow the metal ring in the smaller pocket.

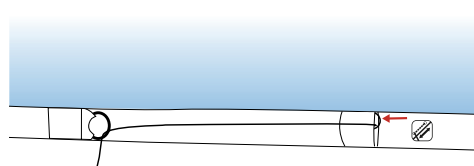

⑦ Done!

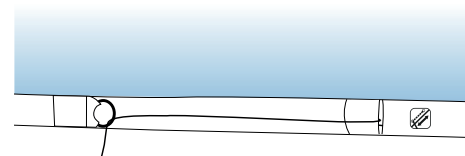

Follow these steps to **extend** the line:

① Pull the metal ring out of the smaller pocket and the excess line length out of the larger pocket.

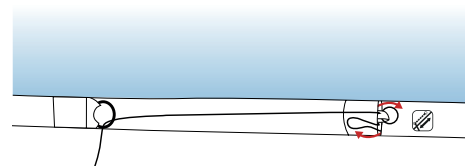

② Loosen the loop, remove it from the metal ring and pull the looped line out of the spliced loop.

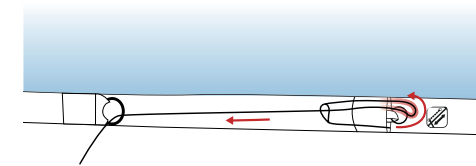

Check „Sport-Mode“:

There is an additional „SPORT“ icon on the binding tape. The transition from the sheathed to the un-sheathed brake top line forms the reference point. If the reference point is located above this icon (tolerance $\pm 1,5\text{cm}$), the respective brake top line is converted into Sport-Mode.



THE MODIFICATION HAS TO BE APPLIED ON BOTH SIDES OF THE WING

You can find further information on practices and characteristics of flying in the enclosed „BASIC GUIDE“.

STARTCHECK

In the general aviation it is standard to use checklists before you take-off. We would like to help you with some pictograms on the A-riser not to forget anything while you make your take-off check:



- **1: Checklist Pilot**
leg strap, main carabiner, chest strap, helmet
- **2: Checklist lines:**
lines free, brake lines free, risers not twisted
- **3: Checklist wing**
wing stretched out and free, leading edge air ducts open, pilot standing in the middle
- **4: Wind Check**
how strong? which direction?
- **Airspace Check**
my take-off should not hinder any other pilots or airspace



ERGO HANDLE

There is a velcro strap on the brake handle with which you can adjust the size of the brake handle.

Hold the brake line tightly between the thumb and the rest of your hand. This way the pilot has better control during launch, in flight and during the landing phase.

The pilot can sense more easily what is happening with the wing and wrapping the brakes during the landing phase is no longer necessary.

7 DESCENT TECHNIQUES

BIG EARS

In contrast to the spiral dive, with big ears your forward speed is higher than your sink speed. This descent method is used to quickly leave dangerous areas in a desired horizontal direction. The danger of canopy disturbances in turbulent air is greatly reduced with big ears.

Proceed as follows:

- Hold the outer A-lines, which are suspended on separate A-risers, below the line shackles and pull down on the lines or risers.
- Keep the brake handles and the outer A-lines in your hands during the maneuver. The glider remains controllable with weight shifting.
- To increase both sink rate and forward speed, you can also optimize this maneuver with the speed bar.
- To recover from the maneuver, release the A-lines and the glider normally will open by itself.
- To speed up the opening, pull on the brakes lightly. It is better to first open one side and then the other to minimize the risk of a possible stall.

Examples:

- If the pilot is surprised near a summit with little ground clearance by strong wind or thundercloud, neither a B-stall nor a spiral dive can help.
- If the pilot is stuck in very strong lift, it is advisable to exit the lift band with the use of big ears and to find sinking air in which to lose altitude.

B-LINE STALL

The B-lines are pulled down symmetrically 15-20cm. Keep the brake handles in the respective hands. The airflow on top of the profile largely detaches and the paraglider descends without flying forward. Pulling hard on the B-risers allows you to decrease the area of the wing and increase your sink rate, but this also increases the risk of the wing forming a rosette to the front. If this happens, recovery from the B-stall immediately!

You can exit the stall by quick and symmetric release of the B-lines. The paraglider will pitch forward and pick up speed. At no time you may use the brakes in this case! If the wing doesn't reopen you may speed up the opening process by gently braking.

You can find further information about descent techniques in the enclosed "BASIC GUIDE".

8 MATERIALS

The skywalk MESCAL6 is manufactured from the highest quality materials. skywalk has selected the best possible combination of materials with regard to resilience, performance and longevity. We are aware that the durability of the glider is a deciding factor in the pilot's satisfaction

WINGS AND RIBS

Upper sail: Porcher Skytex 38g / Skytex Easyfly
 Lower sail: Porcher Skytex Easyfly
 Ribs: Porcher Skytex 40g hard

LEINES

A, B, C Main lines: Liros PPSL 200
 A, B, C Middle lines: Liros PPSL 160/120
 A, B, C Top lines: Liros DSL 70
 Brake lines: Liros DFLP 200/32, DSL 70

RISERS

The risers are made of 20 mm webbing. Stretching values, strength and stability of this material is among the highest of all webbing products available.



9 HOMOLOGATION

The MESCAL6 is certified to LTF 09 and EN926-1, EN926-2 in the category A. The MESCAL6 is defined as a lightweight sport aircraft with an empty weight of less than 120 kg in the paraglider category. The many homologation tests are the last hurdle in the development of a skywalk paraglider. The homologation test flights only take place when the test team is completely happy with the glider development.

We remark that the certification results will differ during flight in thermals or turbulent air. The homologation informs solely regarding the paraglider performance during extreme-flight-manoevres performed in stable air conditions. These extreme-flight-manoevres during the homologation process should thus not be over-valued. Remember that certification maneuvers were carried out with a harness in the group GH with a carabiner distance (middle to middle) of 42-46 cm. If another harness is used, the glider may display flight characteristics that differ from those in the description



10 CLOSING WORDS

The skywalk MESCAL6 is at the pinnacle of paraglider development in the market for novice gliders and shows what is possible regarding performance, safety and innovation. It cost us a lot of time to develop this glider, but it was also a lot of fun. In this development we recognize the challenge of making the right product for every area and individual taste. We are pleased if you notice this during your first flight and if you feel a certain unity with your glider from the very beginning. The MESCAL6 will provide you with plenty of joy over many years if you treat it and care for it properly. Respect for the demands and dangers of our sport are essential for successful and beautiful flights.

Even the safest paraglider can be dangerous due to misjudgments of meteorological conditions or pilot error. Always remember that flying sports are potentially risky and that you are responsible for your own safety. We advise you to fly carefully and to respect laws in the interest of our sport, because every pilot always flies at his or her own risk!

WE WISH YOU A LOT OF FUN WITH YOUR NEW GLIDER AND ALWAYS HAPPY LANDINGS!!

Your skywalk Team

11 LINE SCHEMATIC

This line schematic is only for illustration purposes.

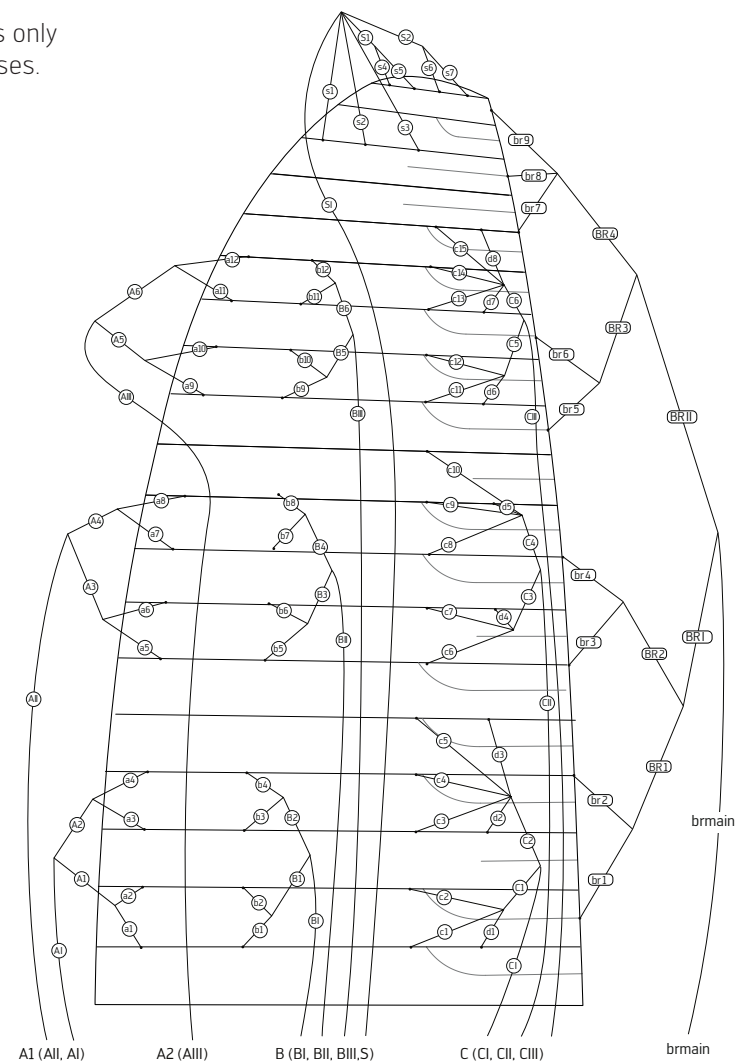

12 LINE LENGTH

Total line length MESCAL6 size XXS, XS, S, M and L: www.skywalk.info

Single line length MESCAL6 size XXS, XS, S, M and L: www.skywalk.info

13 RISERS

MESCAL6, size XXS und XS

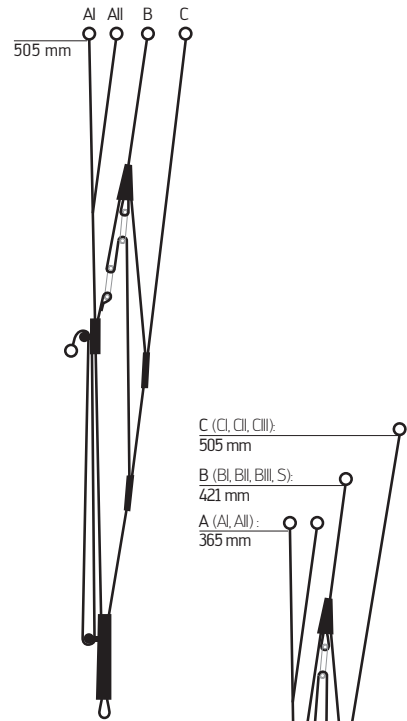

Trim speed

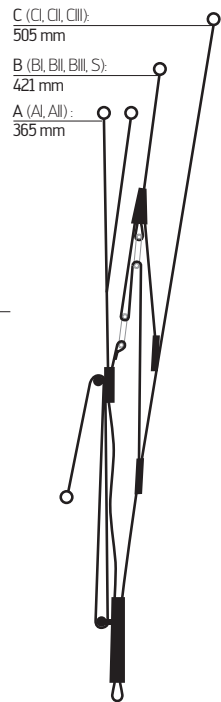

Accelerated flight

C (CI, CII, CIII):
505 mm
B (BI, BII, BIII, S):
421 mm
A (AI, AII):
365 mm

MESCAL6, size S, M und L

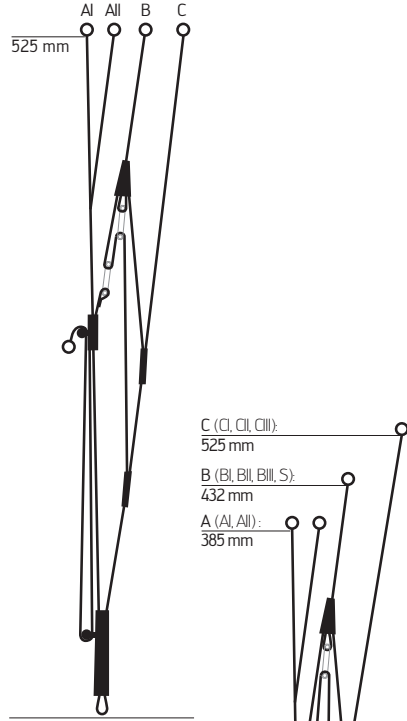

Trim speed

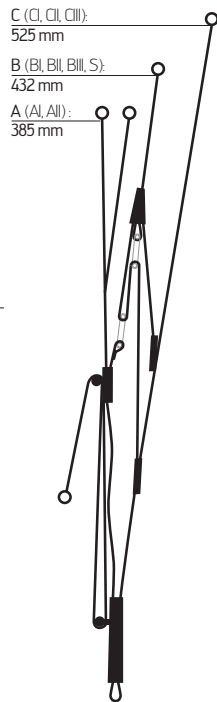

Accelerated flight

C (CI, CII, CIII):
525 mm
B (BI, BII, BIII, S):
432 mm
A (AI, AII):
385 mm

14 OVERVIEW GLIDER

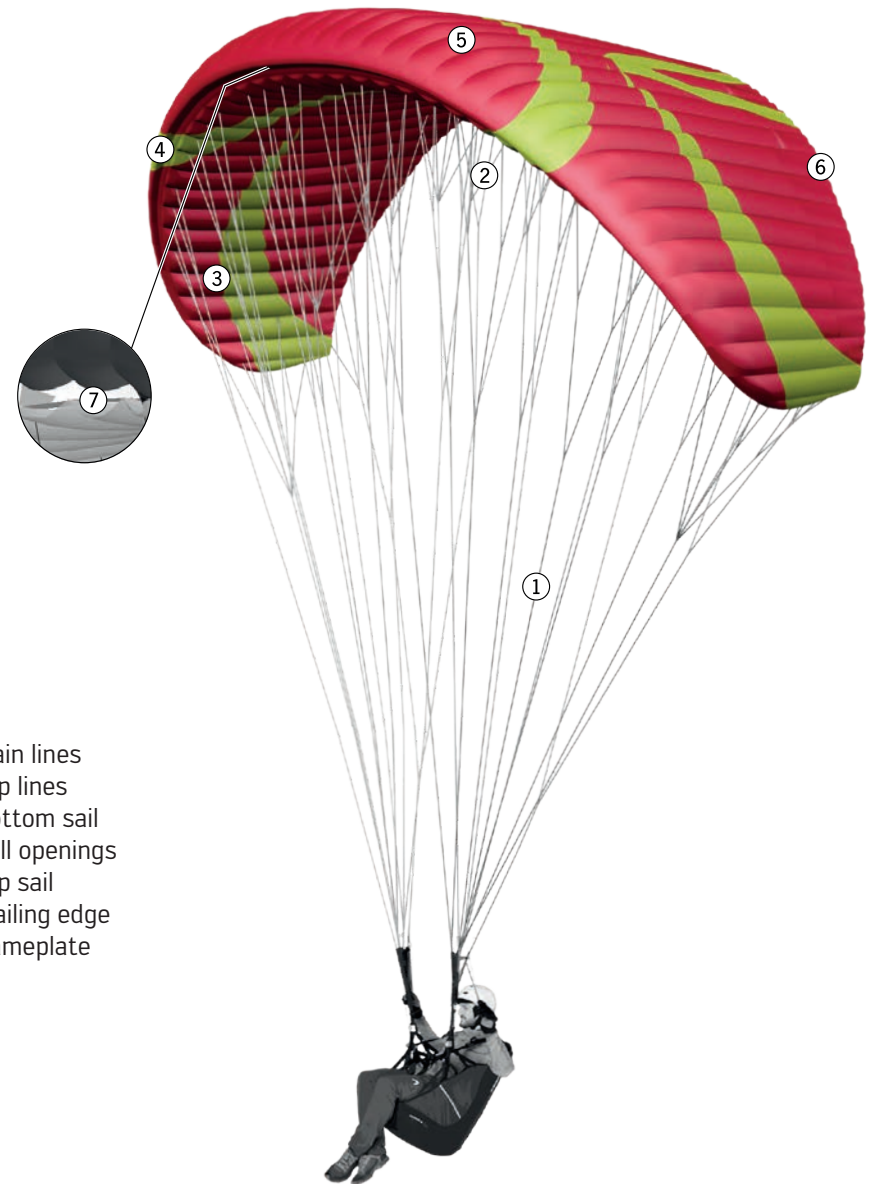

- 1 Main lines
- 2 Top lines
- 3 Bottom sail
- 4 Cell openings
- 5 Top sail
- 6 Trailing edge
- 7 Nameplate

15 TEST PROTOCOL			Date:
Customer, Name:			
Adress:		Phone:	
Glider:	Size:	Serial number:	
Type certificate number:		Date of last check:	
Date of first flight:		Year of construction:	

Accomplished checking:	Results [+/-]:	Description of failure:	Suggested repairs:
Identification:	<input type="checkbox"/> + <input type="checkbox"/> -		
Visual check of canopy:			
Upper surface:	<input type="checkbox"/> + <input type="checkbox"/> -		
Lower surface:	<input type="checkbox"/> + <input type="checkbox"/> -		
Profiles:	<input type="checkbox"/> + <input type="checkbox"/> -		
Line flares:	<input type="checkbox"/> + <input type="checkbox"/> -		
Leading edge:	<input type="checkbox"/> + <input type="checkbox"/> -		
Trailing edge:	<input type="checkbox"/> + <input type="checkbox"/> -		
Crossports:	<input type="checkbox"/> + <input type="checkbox"/> -		
Visual check of lines:			
Seams:	<input type="checkbox"/> + <input type="checkbox"/> -		
Abrasion spots:	<input type="checkbox"/> + <input type="checkbox"/> -		
Core withdrawals:	<input type="checkbox"/> + <input type="checkbox"/> -		
Visual check of connectionparts:			
Suspension line screw locks:	<input type="checkbox"/> + <input type="checkbox"/> -		
Risers:	<input type="checkbox"/> + <input type="checkbox"/> -		
Length measurement:			
Risers:	<input type="checkbox"/> + <input type="checkbox"/> -		
Lines:	<input type="checkbox"/> + <input type="checkbox"/> -		
Examinations of the canopy:			
Firmness of canopy:	<input type="checkbox"/> + <input type="checkbox"/> -		
Porosity:	<input type="checkbox"/> + <input type="checkbox"/> -		

Examinations of the lines:			
Firmness of main lines:	<input type="checkbox"/> <input type="checkbox"/> <input type="checkbox"/> <input type="checkbox"/> <input type="checkbox"/>	daN	
	Results [+/-]:	Description of failure:	Suggested repairs:
Visual check of trimming:	<input type="checkbox"/> + <input type="checkbox"/> -		
Checkflight necessary?	<input type="checkbox"/> + <input type="checkbox"/> -		
Type certificate patch?	<input type="checkbox"/> + <input type="checkbox"/> -		
Identification plate?	<input type="checkbox"/> + <input type="checkbox"/> -		
Condition:	<input type="checkbox"/> New <input type="checkbox"/> Very good condition <input type="checkbox"/> Good condition <input type="checkbox"/> Well used <input type="checkbox"/> Heavily used, but within homologation standards, frequent checks required <input type="checkbox"/> No longer airworthy, outside of the limit values.		
Repairs made?:			
Signature of tester:		Date:	
Name of tester:		Firm stamp:	



Skywalk GmbH & Co. KG
Windeckstr. 4 | 83250 Marquartstein
+49 (0) 8641/69 48 40
info@skywalk.info | www.skywalk.info